

***myprojectorlamps.com***

**The most trusted, dependable name  
in projector lamp sales.**



<http://www.myprojectorlamps.com>



<http://www.myprojectorlamps.ca>



<http://www.myprojectorlamps.eu>

The following projector manual has not been modified or altered in any way.

# EIKI

---

ALL-IN-ONE PROJECTOR  
MODEL EIP-10V



**OWNER'S MANUAL**

**EIKI INDUSTRIAL CO., LTD.**

0.5cm直徑  
打孔處

## Starting EIP-10V

1. Ensure that the supplied power cord is securely connected to the AC inlet and power outlet, and remove the lens cap.
2. Turn On the **MAINS** switch.
3. Ensure that the projector is in Standby mode. (The **Standby/On** Indicator should be green)
4. Press the **Standby/On** button on the Control Panel or the **Power** button on the Remote Control to start the lamp.
5. During lamp warm-up a countdown appears on the screen.(30 seconds)
6. The projector will automatically detect the active input source.

## Use with Computer



VGA Cable



1. Connect the computer to the projector using the VGA cable.
2. If the computer is a notebook, select "clone" mode to send a signal to the projector.
3. The projector will automatically detect the signal.

## Use with Media Player or DVD Player



▲/Photo Rotate  
||/Pause  
▶/Slide



1. Insert a media card or DVD disc into the appropriate slot.
2. Press the **Slide** button to start.
3. The projector will automatically detect the signal.

## Quick Start-Up Guide

**EIKI**  
ALL-IN-ONE PROJECTOR EIP-10V

### Menu



1. Press the **Menu** button to display the Main Menu dialog box.
2. Press the **Left/Right** or **UP/DOWN** buttons to select or change the items.
3. Press the **Enter** button to return to the Main Menu.
4. Press the **Menu** button to quit the Menu.

### Wireless Speakers



1. Select the Audio Sub Menu.
2. Press the **Up/Down** buttons to choose the wireless channel settings.
3. Press the **Left/Right** buttons to set the channel the same as the Wireless speakers.
4. Press the **Menu** button to quit the Menu.

### Remote Control

Control all functions for Projector, DVD and Media Player.

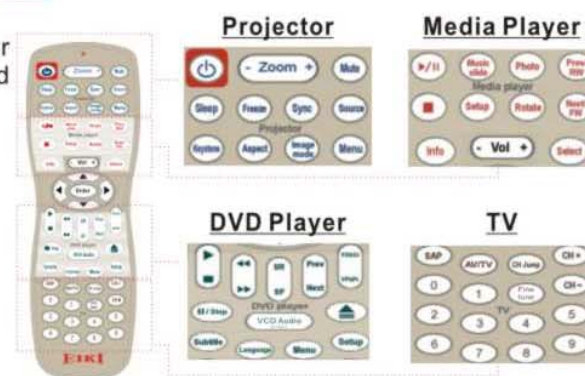







# IMPORTANT SAFETY INSTRUCTIONS

1. Read these instructions.
2. Keep these instructions.
3. Heed all warnings.
4. Follow all instructions.
5. Do not use this apparatus near water.
6. Clean only with a dry cloth.
7. Do not block any of the ventilation openings. Install in accordance with the manufacturer's instructions
8. Do not install near any heat sources such as radiators, heat registers, stoves, or other apparatus (including amplifiers) that produce heat.
9. Do not defeat the safety purpose of the polarized power plug. The plug has two blades, one wider than the other. The wide blade or third prong is provided for your safety. When the provided plug does not fit into your power outlet, consult an electrician for replacement of the obsolete outlet.
10. Protect the power cord from being walked on, or pinched, particularly at the plug, and at the point where the cord exits from the projector.
11. Only use attachments/accessories specified by the manufacturer.
12. Use only with a cart, stand, tripod, or bracket specified by the manufacturer, or sold with the apparatus. When a cart is used, use caution when moving the cart/apparatus combination to avoid injury from tip-over.
13. Unplug this apparatus during lightning storms or when unused for long periods of time.
14. Refer all servicing to qualified service personnel. Servicing is required when the apparatus has been damaged in any way, such as if the power cord or plug is damaged, liquid has been spilled or objects have fallen into the apparatus, the apparatus has been exposed to rain or moisture, does not operate normally, or has been dropped.



# CAUTION LABELS

## ◆ SAFETY CAUTION LABEL

<p>MODEL NAME: All-in-One PROJECTOR MODEL NO.: EIP-10V</p> <p><b>EIKI</b></p>	<p>AC 100-240V 6.0A 50/60 Hz</p> <p>Distributed by EIKI INDUSTRIAL CO., LTD. MADE IN TAIWAN</p>	<p> <b>WARNING!</b> TO AVOID BURNS AND BULB EXPLOSION WHILE REPLACING THE LAMP, TURN THE PROJECTOR OFF AND UNPLUG THE POWER CORD, WAIT OVER 45 MINUTES BEFORE OPENING THE LAMP DOOR. PLEASE FOLLOW THE INSTRUCTION IN THE USER'S MANUAL TO REPLACE THE LAMP.</p>
<p><b>FOR COMMERCIAL USE ONLY</b></p>		
<p>THIS DEVICE COMPLIES WITH PART 15 OF THE FCC RULES. OPERATION IS SUBJECT THE FOLLOWING TWO CONDITIONS:(1) THIS DEVICE MAY NOT CAUSE HARMFUL INTERFERENCE AND (2) THIS DEVICE MUST ACCEPT ANY INTERFERENCE RECEIVED. INCLUDING ANY INTERFERENCE THAT MAY CAUSE UNDESIRED OPERATION.</p>		
<p>WARNING!  NO USER SERVICEABLE PARTS INSIDE. THE PROJECTOR IS OPERATING AT HIGH VOLTAGE SO NEVER OPEN THE CABINET BY YOURSELF. PLEASE REFER SERVICING TO QUALIFIED PERSONAL. EYE DAMAGE MAY RESULT FROM DIRECTLY VIEWING THE LIGHT PRODUCED BY THE LAMP USED IN THIS EQUIPMENT. ULTRAVIOLET RADIATION EYE PROTECTION REQUIRED DURING SERVICING. </p>		
 I.T.E. E243006   		

## ◆ INDOOR USE CAUTION LABEL

The projector is for indoor use only.



## ◆ EYE INJURY CAUTION LABEL

To avoid damage to eyes ,do not look into the projector's lens when the lamp is on.

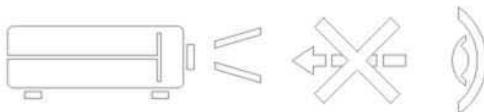

# COMPLIANCE

## ◆ FCC WARNING STATEMENT

This device complies with Part 15 of the FCC Rules. Operation is subject to the following two conditions: (1) this device may not cause harmful interference and (2) this device must accept any interference received, including interference that may cause undesired operation.

---

### a.15.105 Federal Communications Commission (FCC) Requirements, Part 15

This equipment has been tested and found to comply with the limits for a class B digital device, pursuant to part 15 of the FCC Rules. These limits are designed to provide reasonable protection against harmful interference in a residential installation.

This equipment generates, uses and can radiate radio frequency energy and, if not installed and used in accordance with the instructions, may cause harmful interference to radio communications. However, there is no guarantee that interference will not occur in a particular installation. If this equipment does cause harmful interference to radio or television reception, which can be determined by turning the equipment off and on, the user is encouraged to try to correct the interference by one or more of the following measures:

- Consult the dealer or an experienced radio/TV technician for help.
- Reorient or relocate the receiving antenna.
- Increase the separation between the equipment and receiver.
- Connect the equipment into an outlet on a circuit different from that to which the receiver is connected.

---

### b. Regulatory information / Disclaimers

Installation and use of this DLP Projector must be in strict accordance with the instructions included in the user documentation provided with the product. Any changes or modifications (including the antennas) made to this device that are not expressly approved by the manufacturer may void the user's authority to operate the equipment. The manufacturer is not responsible for any radio or television interference caused by unauthorized modification of this device, or the substitution of the connecting cables and equipment other than manufacturer specified. It is the responsibility of the user to correct any interference caused by such unauthorized modification, substitution or attachment. Manufacturer and its authorized resellers or distributors will assume no liability for any damage or violation of government regulations arising from failing to comply with these guidelines.

---

c. MPE Statement (Safety Information)

---

Your device contains a low power transmitter. When the device is transmitting it sends out Radio Frequency (RF) signal.

Safety Information

In order to maintain compliance with the FCC RF exposure guidelines, this equipment should be installed and operated with a minimum distance 20cm between the radiator and your body. Use only with the supplied antenna. Unauthorized antenna, modification, or attachments could damage the transmitter and may violate FCC regulations.

◆ **CE WARNING STATEMENT**

CE Declaration of Conformity

For the following equipment:

Is herewith confirmed to comply with the requirements set out in the Council Directive on the Approximation of the Laws of the Member States relating to Electromagnetic Compatibility (89/336/EEC), Low-voltage Directive (73/23/EEC) and the Amendment Directive (93/68/EEC), the procedures given in European Council Directive 99/5/EC and 89/3360EEC.

The equipment was passed. The test was performed according to the following European standards:

EN 300 440-2 V.1.1.1 (2001-09)

EN 301 489-1 V.1.3.1 (2001-09) / EN 301 489-17 V.1.1.1 (2000-09)

EN 60950: 2000

# TABLE OF CONTENTS

Precautions	6
<b>1. Product Overview</b>	<b>7</b>
1-1 Features	7
1-2 Package Contents	8
1-3 Main Unit	9
1-4 Control Panel	10
1-5 Rear Terminals	10
<b>2. Installation</b>	<b>11</b>
2-1 Powering On/Off the Projector	11
2-1-1 Powering On the Projector	11
2-1-2 Powering Off the Projector	11
2-1-3 LED Indication Status	12
2-2 Adjusting the Projector Image	13
2-2-1 Adjusting the Projector Height	13
2-2-2 Adjusting the Projector Zoom/Focus	13
2-2-3 Adjusting the Projection Image Size	14
2-3 Operation	14
2-3-1 Connecting to a Personal Computer	14
2-3-2 Operating the Media Player	15
2-3-3 Operating the DVD Player	19
2-3-4 Operating the Wireless Speaker	20
<b>3. Control Panel and Remote Control</b>	<b>21</b>
3-1 Control Panel and Remote Control	21
3-1-1 Using the Control Panel	21
3-1-2 Using the Remote Control	22
3-2 On-Screen Display Menus	25
3-2-1 How to Operate	25
3-2-2 Projector's OSD (On-Screen-Display)	25
3-2-3 Media Player's OSD (On-Screen-Display)	30
3-2-4 DVD Player's OSD (On-Screen-Display)	34
<b>4. Appendices</b>	<b>38</b>
4-1 Troubleshooting	38
4-2 Maintenance	40
4-2-1 Replacing the Lamp	40
4-2-2 Cleaning the Projector	42
4-3 Specifications	43



# PRECAUTIONS

These precautions are intended to ensure the long life of your projector and to prevent personal injury. Please read the following instructions carefully before using the projector.

1. Do not look into the projector's lens when the lamp is on.
2. Clean the lens carefully by using a blower or lens paper, to avoid creating any scratches on the lens.
3. In order to avoid risk of electrical shock, do not expose the projector to rain or moisture.
4. Do not push anything inside the projector through the ventilation holes or the slots of the DVD player or Media player.
5. Do not allow the ventilation holes to become covered by things such as tablecloths, newspapers, curtains, etc. Place the projector in a well-ventilated area because it generates high temperatures.
6. Do not place objects on the top of this unit, such as:
  - Other components, as they may cause damage and /or discoloration to the surface of this unit.
  - Burning objects (ex. candles), as they may cause fire, damage to this unit, and /or personal injury.
7. Only use the supplied power cord and accessory cables. Do not attempt to modify or fix the unit. The cabinet should never be opened for any reason. Contact a qualified service person if any service is needed.
8. When the lamp's accumulated working time exceeds 1850hrs, the On Screen Display will deliver a message recommending that the lamp be replaced. Before replacing the lamp, be sure to turn the projector off, disconnect the power cord, and allow the unit to cool off for at least one hour.
9. Do not operate the projector immediately after exposing it to a sudden change in temperature, from cold to hot . Do not locate the projector in an environment with high humidity. These measures are intended to prevent the formation of condensation inside this unit, which could cause fire, damage to this unit, and/or personal injury.
10. Be sure that the projector completes its cooling cycle (90sec) before disconnecting the power cord.

# 1 PRODUCT OVERVIEW

## 1-1 FEATURES

- ◆ One panel 0.7" DDR DMD projection system with 1024 x 768 (XGA) native resolution.
- ◆ Uses Zeiss Optical Engine to provide light output of 1800 ANSI lumens.
- ◆ High contrast ratio of 2000:1(FOFO) to meet home theater requirements.
- ◆ 250 W P-VIP lamp. Life 2000hrs at Normal mode, 3500hrs in Eco mode (200W).
- ◆ High efficiency cooling system with low system acoustic noise level: under 32dBA.
- ◆ Lamp is easily replaceable by user.
- ◆ Manual zoom and focus lens with a 1:1.2 zoom ratio and 100% lens offset.
- ◆ 35 to 300 inch diagonal image size.
- ◆ 16.7million true colors.
- ◆ Aspect ratio: standard 4:3 and wide screen 16:9.
- ◆ PC compatibility: VGA/SVGA/XGA/SXGA/MAC.
- ◆ Video compatibility: NTSC/PAL/SECAM/Composite/S-video/Component (YPbPr/YCbCr)/SDTV (480i)/EDTV (480p)/HDTV (576i, 576p, 720p, 1035i, 1080i).
- ◆ Auto Image synchronization. (Auto-tracking /frequency /position adjustment / source detect)
- ◆ Automatically saves adjustments for future use.
- ◆ On-screen menu with a choice of 7 languages.
- ◆ Built-in 2W x 1 speaker.
- ◆ Self protection timer prevents hot re-strike of compact P-VIP lamp.
- ◆ Built-in DVD Player with intelligent progressive scan for a film-like image.
- ◆ Integrated Stereo Wireless Amplified Speakers.
- ◆ Built-in wireless Transmitter module (for Stereo Wireless Amplified Speakers).
- ◆ Media Player (card compatibility: CF, IBM Microdrive, MS, SD, MMC, SM).
- ◆ Five in one Wireless remote control .(Projector, Wireless Speakers, Media player, TV tuner, DVD Player)
- ◆ Security feature: Kensington Lock.
- ◆ Optional TV tuner.

# PRODUCT OVERVIEW

## 1-2 PACKAGE CONTENTS

◆ EIP-10V projector x 1



◆ PC audio cable x 1



◆ VGA cable x 1



◆ Remote Control x 1



◆ Owner's manual & Quick Start Up card x 1



◆ Power cord(US) x 1



◆ Power cord(EU) x 1



◆ AAA Batteries x 2



◆ Mac adapter x 1



◆ Soft carry bag x 1



## 1-3 MAIN UNIT



DRAWING 1

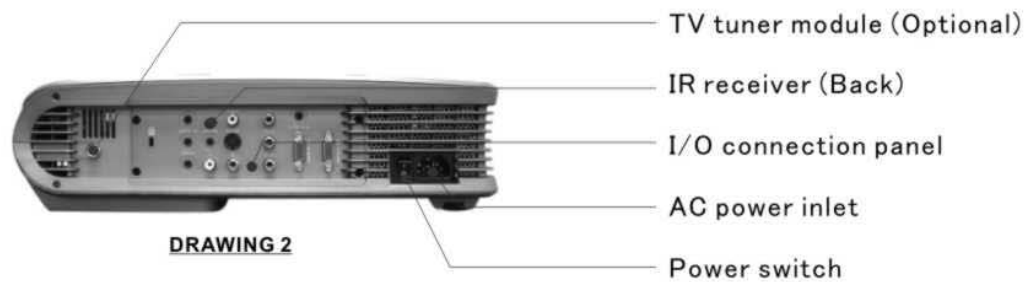

DRAWING 2



DRAWING 3



DRAWING 4

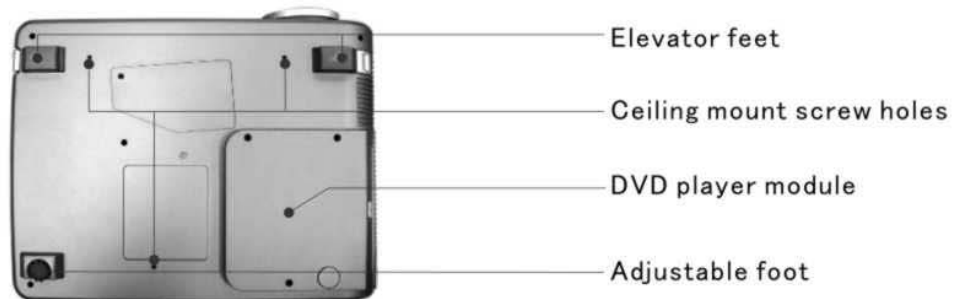

DRAWING 5

# PRODUCT OVERVIEW

## 1-4 CONTROL PANEL

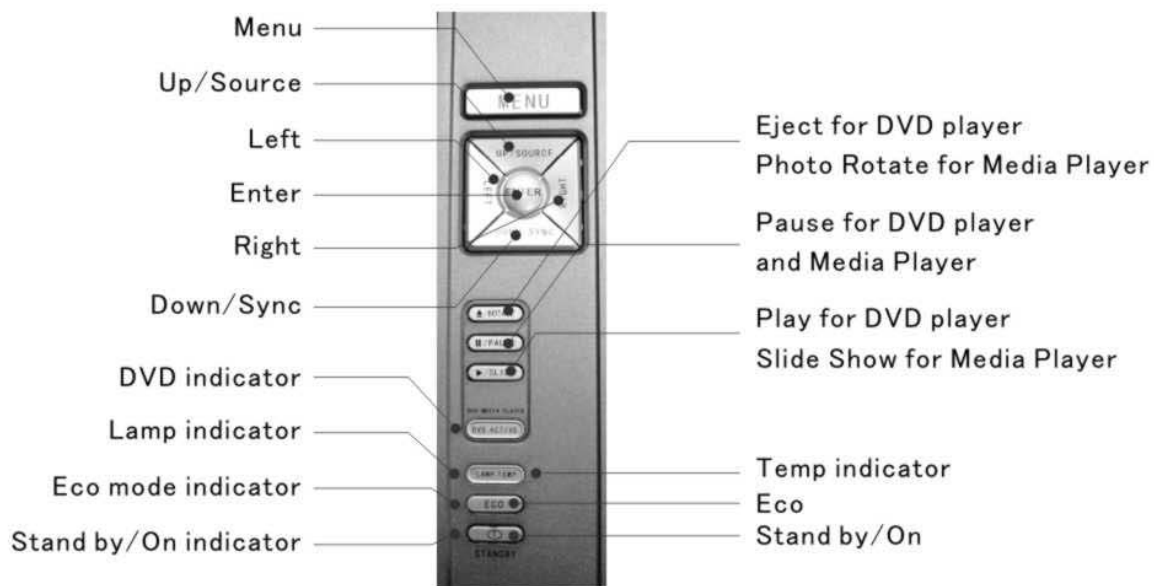

DRAWING 6

## 1-5 REAR TERMINALS

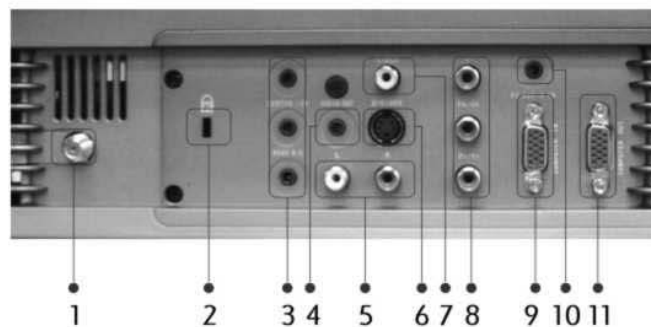

DRAWING 7

1. TV input (Optional)	7. Composite Video input
2. Kensington Lock	8. Component Video input (YPbPr/YCbCr)
3. Audio output (5.1 channels)	9. VGA input
4. Audio output	10. PC audio in
5. Audio input (R/L)	11. VGA output
6. S-Video input	

# 2 INSTALLATION

## 2-1 POWERING ON/OFF THE PROJECTOR

### 2-1-1 POWERING ON THE PROJECTOR

1. Ensure that the supplied power cord is securely connected at the AC inlet of the projector (Drawing 8) and power outlet.
2. Remove the lens cap.
3. Turn on the power switch. Ensure the "Standby/On" button on the Control Panel is flashing green, indicating the projector is in Standby mode.
4. Turn on the Lamp by pressing the "Standby/On" button on the Control Panel or the "Power" button on the Remote Control. Ensure that the "Standby/On" button is continuous green, indicating the projector is on.
5. The start-up screen appears on the screen and starts to count down for 30 seconds.
6. The projector will detect the input source automatically.
7. Play your source device

DRAWING 8

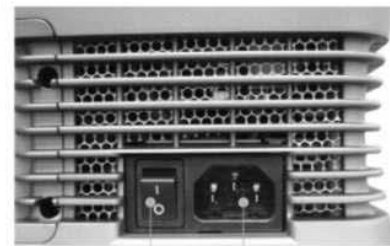

Power switch

AC inlet

### 2-1-2 POWERING OFF THE PROJECTOR

1. Turn off your source device first.
2. Press the "Standby/On" button on the Control Panel or press the "Power" button on remote control, and a message "If no disk in the DVD slot push again "Standby/On" button to turn off." will show on the screen.
3. Promptly press the "Standby/On" button or the "Power" button again to confirm turning off the projector. Otherwise the message will disappear after 5 seconds
4. The projector will begin a 90 second cooling down phase.  
  
Note: Please don't turn off the power switch or disconnect the power cord during the cooling down period.
5. When the projector has cooled down, the "Standby/On" button on the Control Panel will be flashing green, indicating the projector is in Standby mode.
6. Turn off the power switch. Replace the lens cap.
7. Disconnect the power cord from the AC inlet of the projector and power outlet.

# INSTALLATION

## 2-1-3 LED INDICATION STATUS

Condition	Standby/On Indicator	Lamp Status Indicator	Temperature Status Indicator	Eco mode indicator	DVD active indicator	Note
1. Standby	Flashing Green (1sec interval)	-	-	-	-	Waiting for power on
2. Operating	Green	Green	-	-	-	Normal operation
3. Cooling	Green	-	-	-	-	Cool lamp down for 90 sec
4. Eco mode in use	Green	Green	-	Green	-	Eco mode is being used
5. DVD in use	Green	Green	-	-	Green	DVD player is being used.
6. Fan failure	Green	Flashing Green (0.5 sec Interval)	-	-	-	Fan failure. There is a warning message displayed on screen then the projector will power itself off.
7. Overheating	Green	-	Red	-	-	Overheating in the projector: There is a warning message displayed on screen then the projector will power itself off.
8. Overheating while starting	-	-	Flashing Red (1 sec interval)	-	-	The system will cool itself down for 8 sec automatically.

## 2-2 ADJUSTING THE PROJECTOR IMAGE

### 2-2-1 ADJUSTING THE PROJECTOR HEIGHT

1. Press the Elevator buttons. (Drawing 9 and 10)
2. Raise the projector to the desired display angle, allowing the legs to extend, and then release the buttons to lock them in position.
3. Use the Adjustable foot (Drawing11) at the rear of the unit to fine-tune the display angle.
4. Use the Keystone key on the Remote Control or in the OSD to correct any distortion caused by tilting the projector. (Drawing12)

**DRAWING 9**



**DRAWING 10**

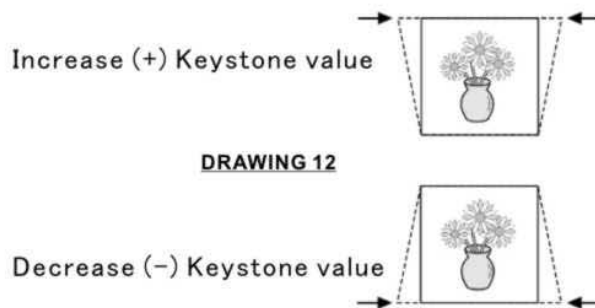

**DRAWING 11**



### 2-2-2 ADJUSTING THE PROJECTOR ZOOM/FOCUS

Adjust the Zoom ring to adjust image size. Rotate the Focus ring to focus the image. The projector will focus at distances from 1.5m (60in. / 5 ft.) to 10m (394 in. / 32.9 ft.). The optimum distance is from 1.5 m to 5 m (197 in. / 16.5 ft.).

**DRAWING 13**





# INSTALLATION

## 2-2-3 ADJUSTING THE PROJECTION IMAGE SIZE

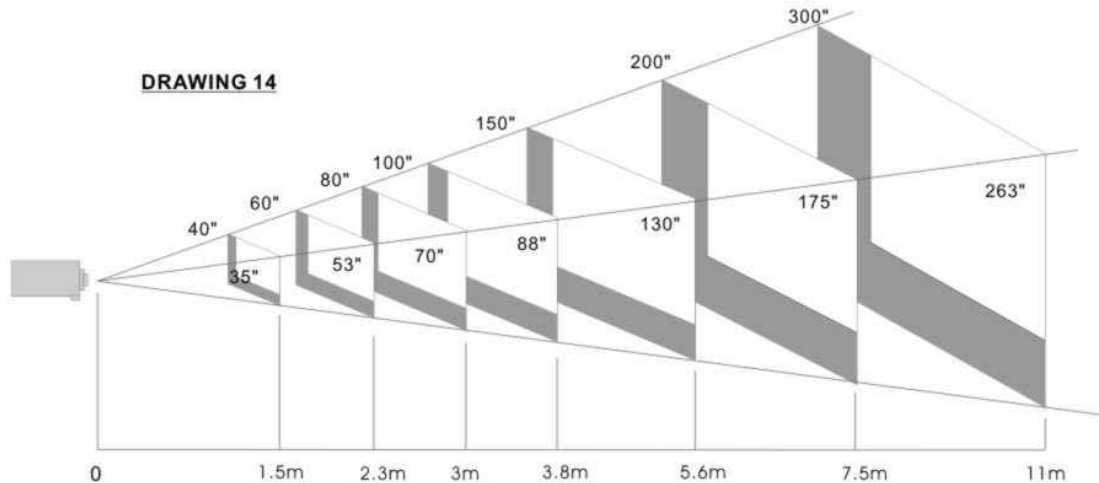

Distance To Screen (Meter/Inch)	1.5/60	2.3/91	3.0/119	3.8/150	5.6/220	7.5/295	11/434
Max. Screen Diagonal (Meter/Inch)	1.02/40	1.52/60	2.03/80	2.54/100	3.81/150	5.08/200	7.62/300
Min. Screen Diagonal (Meter/Inch)	0.88/35	1.35/53	1.78/70	2.24/88	3.30/130	4.45/175	6.68/263

## 2-3 OPERATION

### 2-3-1 CONNECTING TO A PERSONAL COMPUTER

#### ◆ Connecting to a Notebook

1. Use the VGA cable to connect your Notebook to the projector. (Drawing 15)
2. Press the "Monitor Output" function key of your Notebook.
3. The projector will automatically detect the source. If not, please press the "Source" button on the Control Panel of the projector or on the Remote Control to select the computer source.

**DRAWING 15**

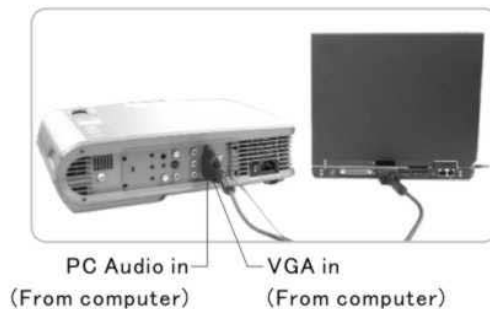

**DRAWING 16**

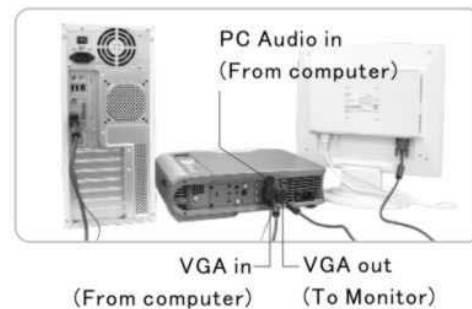







## ◆ Connecting to a Desktop Computer

1. Use the VGA cable to connect your Desktop Computer to the projector. (Drawing 16)
2. Connect the monitor's VGA cable to the projector.
3. The projector will automatically detect the source. If not, please press the "Source" button on the Control Panel of the projector or on the Remote Control to select computer source.

## 2-3-2 OPERATING THE MEDIA PLAYER

The Media Player can support many types of memory cards. See the chart below.

Slot on Projector (Drawing 17)	Slot #1	Slot #2			Slot #3	
Type	SM	MMC	SD	MS	MD	CF
	Smart Media	Multi Media Card	Secure Digital	(Memory Stick)	IBM Micro Drive	Compact Flash Type I / Type II
Length x Width x Thickness (mm)	37x45x0.76	32x 24x1.4	32x 24x2.1	50x21.5x2.8	43x36.4x5	Type I : 43x36.4x3.3 Type II: 43x36.4x5.0
Reference Picture						



Media Player

**DRAWING 17**



Slot 1 (SM)

Slot 2 (SD/MS/MMC)

Slot 3 (CF(I/II)/MD)

**DRAWING 18**

# INSTALLATION

## 2-3-2-1 INSERTING AND REMOVING MEMORY CARDS

There is no need to turn off the power to insert or remove a memory card. As long as you are not viewing files on the card being removed, memory cards can be inserted and removed from the Media Player anytime.

1. Open the "Media Player" Cover smoothly.(Drawing 17)
2. Insert cards into the slots. (Drawing 18) (Different cards can be inserted simultaneously.)
3. Push cards gently until they stop. If a card does not insert easily, please check its orientation.
4. The projector will automatically detect the source when a card is inserted. If not, please press the "Source" button on the Control Panel of the projector or on the Remote Control to cause the projector to select the Media Player source.
5. To remove a card, pull it out from the slot.

## 2-3-2-2 CONTROL PANEL ON THE PROJECTOR

Please refer to the section 3-1-1.

## 2-3-2-3 REMOTE CONTROL

Please refer to the section 3-1-2

## 2-3-2-4 START-UP SCREEN OF THE MEDIA PLAYER

When memory cards are inserted simultaneously, the card selection screen is displayed as shown in Drawing 19.

### 1. Card selection

Press the "Up" or "Down" buttons on the Control Panel or Remote Control to choose the card you want to play. Press "Enter" to select.

Once a card is selected, or if only one card is inserted, the file selection screen is displayed as shown in Drawing 20.

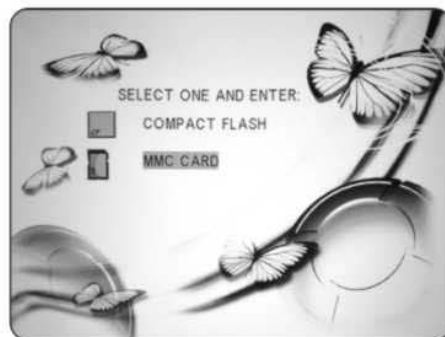

DRAWING 19

## 2. MUSIC, PHOTO, MOVIE, FILE are shown on screen (Drawing 20)

### ◆ Playing MP3 Music Files

MP3 (MPEG Audio Layer 3) is an audio compression technology that compresses CD-quality sound to a fraction of its size. The resulting MP3 files lose a little of the original sound quality, but the smaller file size means songs can easily fit even on smaller memory cards.

1. Press the "Right" or "Left" button to choose the "MUSIC" folder.(Drawing 20)
2. Open the MUSIC LIBRARY by pressing the "Enter" button. (Drawing 21)
3. Press the "Up" or "Down" button to choose the song you want. Press the "Play" button to start.
4. Press the "Select" button on the Remote Control to return to the start-up screen.



**DRAWING 20**

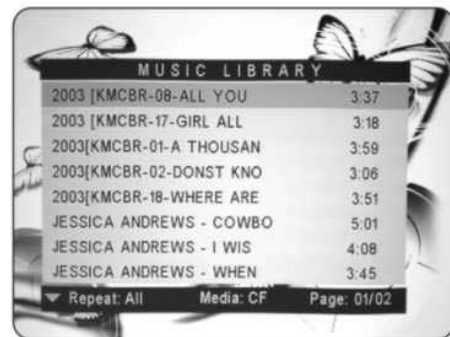

**DRAWING 21**

### ◆ Viewing Photos and Playing Slideshow

The trend for storing photos in digital format is ongoing. Images are usually stored in JPEG (\*.jpg) format. The JPEG (Joint Photographic Experts Group) standard for compressing still images is very popular due to its high compression capability.

#### Viewing Photos

1. Press the "Right" or "Left" button to select the "PHOTO" folder. (Drawing 22)
2. Open the PHOTO ALBUM by pressing the "Enter" button.
3. It will take 2 to 3 sec to display the thumbnail on the screen. (Drawing 23)
4. Use the "Cursor" buttons to select the photo you want and press the "Play" button to display it full size.

# INSTALLATION

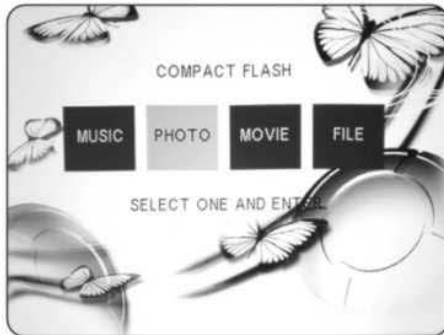

**DRAWING 22**



**DRAWING 23**

Playing Slideshow (Refer to the Slideshow setup in section 3-2-3-4 for a detailed explanation of slideshow settings)

Press the "Slide" button on the Control Panel or the "Music slide" button on the Remote Control to start the slideshow with music (MP3 music if available in your memory card) when the Photo thumbnail screen is shown. (Drawing 23)

## ◆ Viewing Movies

The Media Player supports playback of MPEG-1 and MPEG-2 movie clips.

MPEG (Moving Pictures Experts Group) is a standard for compressing video. MPEG-1 is used in CD-ROMs and Video CDs, and provides 24-bit color and CD-quality sound. MPEG-2 supports a variety of audio/video formats, including legacy TV, HDTV and five-channel surround sound. It provides the broadcast-quality image of 720x480 resolution that is used in DVD movies.

1. Press the "Right" or "Left" button to select the "MOVIE" folder. (Drawing 24)
2. Use the "Cursor" button to select the clip you want and press the "Play" button to start. (Drawing 25)



**DRAWING 24**



**DRAWING 25**

## ◆ Viewing All Files

1. Press the "Right" or "Left" button to select the "FILE" folder. (Drawing 26)
2. Press the "Enter" button to open the FILE LIBRARY folder. (Drawing 27)
3. Use the "Cursor" buttons to choose the desired folder, and press the "Enter" button to select it, then use the "Cursor" buttons to choose the file you want to view, and press the "Enter" button to start.

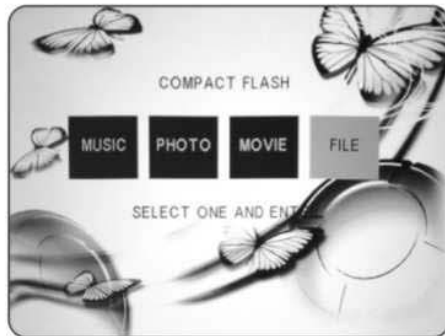

**DRAWING 26**

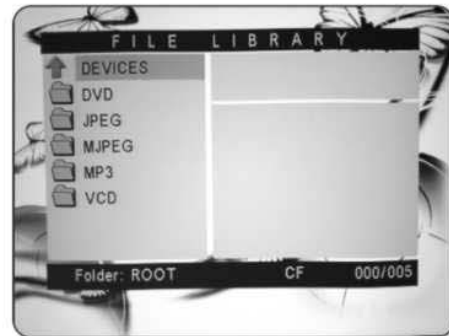

**DRAWING 27**

## 2-3-3 OPERATING THE DVD PLAYER

Insert your disc into the DVD Player's slot on the Projector. (Drawing 28)

The projector will automatically detect the source. If not, please press the "Source" button on the Control Panel or on the Remote Control to select the DVD Player source.

Press the "Play" button on the Control Panel or on the Remote Control to play a DVD.



**DRAWING 28**

### 2-3-3-1 PANEL CONTROL ON THE PROJECTOR

Please refer to the section 3-1-1.

### 2-3-3-2 REMOTE CONTROL

Please refer to the section 3-1-2

# INSTALLATION

## 2-3-4 OPERATING THE WIRELESS SPEAKER

### 2-3-4-1 CONNECTING THE SPEAKERS



DRAWING 29

### 2-3-4-2 OPERATING THE SPEAKERS

- Make sure the AC voltage selector (115V or 230V) is selected for your local voltage (Factory preset is on 230V).
- Connect the power cord into a wall outlet.
- Turn on the power switch on the rear panel of the speaker.
- Make sure the wireless channel of the speaker that is selected is the same as the wireless channel of the transmitter that is selected in the projector. (Please check the OSD, it will be described in the section of "3-2-2-4 Audio")
- Adjust the volume with volume knob on the rear panel of the speaker.

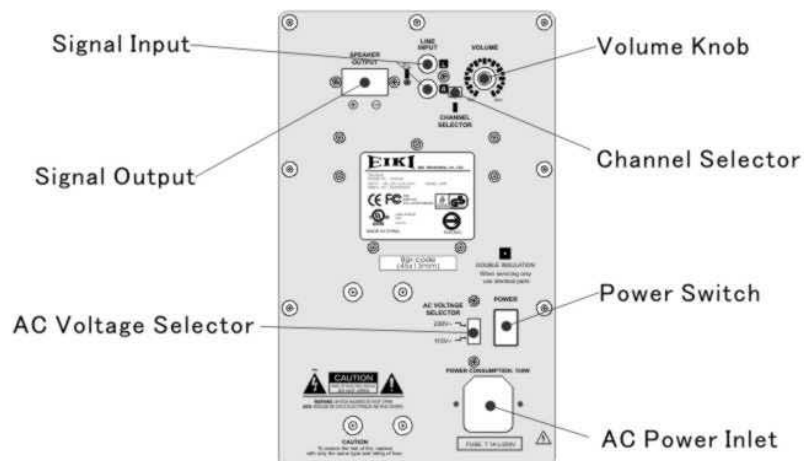

DRAWING 30

# 3 CONTROL PANEL AND REMOTE CONTROL

## 3-1 CONTROL PANEL AND REMOTE CONTROL

You can control the projector's functions through the Control Panel and Remote Control.

### 3-1-1 USING THE CONTROL PANEL

1. **MENU:** Press once to display the OSD. Press again to exit the OSD.
2. **UP/SOURCE:** This button is dual function.  
**UP:** Cursor function or make an adjustment based on your selection of a function.  
**SOURCE:** Selects "Composite Video", "S-Video", "Component-I Video (YCbCr)", "Analog YPbPr", "DVD Player", "Media player", "Computer", "TV" sources.
3. **DOWN/SYNC:** This button is dual function.  
**DOWN:** Cursor function or make an adjustment based on your selection of a function.  
**SYNC:** Optimizes the signal from PC
4. **LEFT:** Cursor function or make an adjustment based on your selection of a function.
5. **RIGHT:** Cursor function or make an adjustment based on your selection of a function.
6. **ENTER:** Confirms your selection item.
7. **EJECT/ROTATE:** This button is dual function.  
**EJECT:** Eject a DVD  
**ROTATE:** Rotates the photo 90 degrees clockwise on screen, but this function can't be accessed when Slideshow is playing.
8. **II/PAUSE:** This button is dual function.  
**II:** Pauses when playing the DVD disc.  
**PAUSE:** Pauses when playing photos.
9. **PLAY/SLIDE:** This button is dual function.  
**PLAY:** Plays a DVD.  
**SLIDE:** Displays the photos on your memory card as a slide show, with (MP3) music if available on your memory card.
10. **ECO:** Using the projector in this mode will save lamp life and reduce fan noise. You can use this mode for watching video in a room with reduced ambient lighting.

DRAWING 31





# CONTROL PANEL AND REMOTE CONTROL

## 3-1-2 USING THE REMOTE CONTROL



DRAWING 32

LED indicator



DRAWING 33

# CONTROL PANEL AND REMOTE CONTROL

There are five sections on the Remote Control as described below.

**LED indicator:** The LED will light when the Remote Control is functioning. If not, please check your batteries.

## ◆ Section A: BLUE characters, for PROJECTOR use

1. **POWER:** Powers On/Off the projector
2. **ZOOM-:** Reduces the image size (For projector use)
3. **ZOOM+:** Increases the image size (For projector use)
4. **MUTE:** Mutes the audio output. Press once for Mute on, press again for mute off.
5. **SLEEP:** Turns off the projector after a period. (So the time you need---Off, 15min, 30min, 45min, 60min)
6. **FREEZE:** Freezes the image.
7. **SYNC:** Optimizes the signal from PC
8. **SOURCE:** Selects "Composite Video", "S-Video", "Component-I Video (YCbCr)", "Analog YPbPr", "DVD Player", "Media player", "Computer", "TV" sources.
9. **KEystone:** Adjusts image distortion caused by tilting the projector (+/- 12 degree)
10. **ASPECT:** Selects the aspect ratio.(4:3,16:9,1:1)
11. **IMAGE MODE:** Three modes can be selected. (Theater/Computer, Standard, User)
12. **MENU:** Displays the MENU of your playing device. Press once to display, twice to disappear.

## ◆ Section B: RED characters, for MEDIA PLAYER use

13. **PLAY and PAUSE:**  
**PLAY:** Plays program  
**PAUSE:** Pauses the program.  
When playing slideshow with music, press once to pause the slideshow, press again to pause the MP3 music.
14. **MUSIC SLIDE:** Plays slideshow with music
15. **PHOTO:** Plays the photos
16. **PREV/RW**  
**PREV:** Selects the previous photo  
**RW:** Rewinds the program
17. **STOP:** Stops the program
18. **SETUP:** Enters the OSD of the Media player. (If you are playing a program, please stop it first).
19. **ROTATE:** Rotates the photo (This function can't be executed when playing a slideshow)
20. **NEXT and FW:**  
**NEXT:** Selects the previous photo  
**FW:** Forward the program
21. **INFORMATION:** Shows the information (resolution) of the displaying photo.
22. **SELECT:** a. Selects the card you want when different cards are inserted simultaneously.  
b. Return to start-up screen.

## CONTROL PANEL AND REMOTE CONTROL

### ◆ Section C: BLACK Characters, for ANY SOURCE use

These are "Common Keys". They can be used with any source.

23. VOL -: Decreases the volume of either the internal speaker or the external speaker.
24. VOL +: Increases the volume of either the internal speaker or the external speaker.
25. UP: Moves up when selecting item.
26. LEFT: Moves left when selecting item.
27. RIGHT: Moves right when selecting item.
28. DOWN: Moves down when selecting item.
29. ENTER: Confirms your selection.

### ◆ Section D: GREEN characters, for DVD PLAYER use

30. PLAY: Plays the program.
31. STOP: Stops the program.
32. FF: Fast-forwards the program.
33. FR: Fast-rewinds the program.
34. SF: Slow-forwards the program.
35. SR: Slow-rewinds the program.
36. NEXT: Selects the next song or chapter.
37. PREV: Selects the previous song or chapter.
38. YCbCr: This key can't be used on this model.
39. YPbPr: This key can't be used on this model.
40. PAUSE/STEP:  
PAUSE: Pauses the program.  
STEP: Plays the disc step by step.
41. VCD AUDIO: Selects a VCD language. (if the VCD is recorded in two languages) This function can't work while playing a DVD.
42. EJECT: Ejects the disc from the DVD player.
43. SUBTITLE: Selects the language of the subtitle.
44. LANGUAGE: Selects the language of the dub. (If the disc is recorded with multi-language)
45. MENU: Enters the menu of the DVD disc.
46. SETUP: Stops the program, press this button to enter the OSD of the DVD player, and then set the function you need.

### ◆ Section E: BROWN characters, for TV TUNER use

47. SAP: Second audio program.
48. AV/TV: Changes the mode between AV and TV
49. CH JUMP: Channel jump.
50. CH +: Next channel
51. CH -: Previous channel
52. Fine tune: Fine tune the TV signal
53. 0-9 KEYS: Selects the TV channel.

# CONTROL PANEL AND REMOTE CONTROL

## 3-2 ON-SCREEN DISPLAY MENUS

### 3-2-1 HOW TO OPERATE

1. To Open the ON-Screen Display (OSD) menu, press the "Menu" button on the Remote Control or Control Panel.
2. When the OSD is displayed, use "Cursor" buttons on the Control Panel or on the Remote Control to choose the item you need.
3. Press the "Menu" button again to exit.

### 3-2-2 PROJECTOR'S OSD

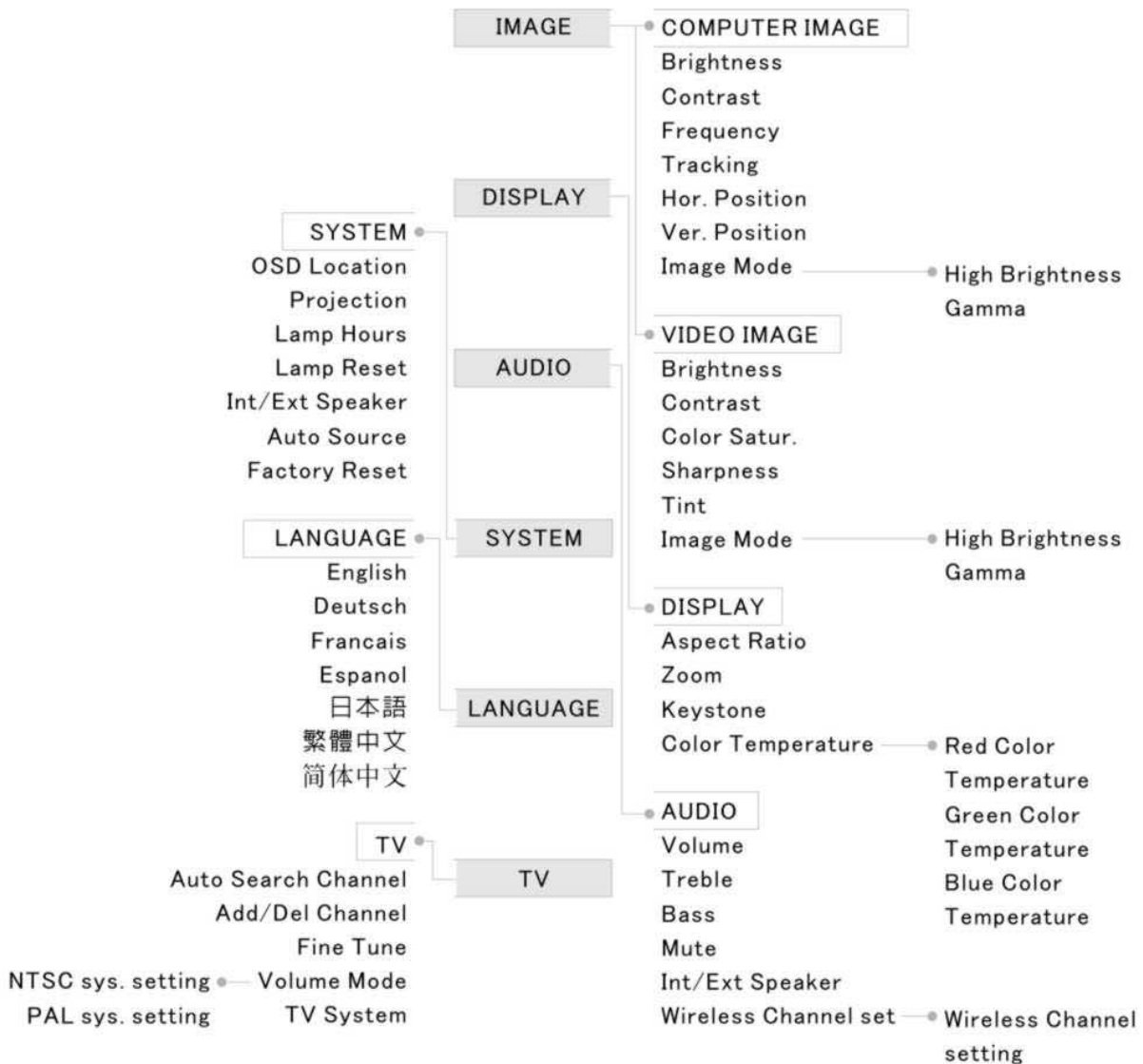

# CONTROL PANEL AND REMOTE CONTROL

## 3-2-2-1 MAIN MENU

Press the "Enter" button to enter the submenu, press it again to return to the main menu.

Main Menu includes:

- Image
- Display
- Audio
- System
- Language
- TV



DRAWING 34

## 3-2-2-2 IMAGE

### ◆ Computer Image

**Brightness:** Adjusts the brightness of the image.

**Contrast:** Adjusts the contrast of the image

**Frequency:** Adjusts the frequency to match the frequency of your computer's graphic card.

**Tracking:** Synchronizes the signal timing with your computer's graphic card.

**Hor. Position:** Moves the image's horizontal position.

**Ver. Position:** Moves the image's vertical position.

**Image Mode:** Choose a mode

**Computer:** This mode is good for computer signals.

**Standard:** This mode is good for movie pictures.

**User:** This mode allows you to adjust High Brightness and/or Gamma. Press the "Right" button to enter the submenu.

**High Brightness:** Sets the white peaking level of the DMD chip. If you prefer a stronger image, press the "Right" button to increase the value. If you want a more natural image, press the "Left" button to decrease the value.

**Gamma:** Adjusts the Gamma (mid-tone brightness) curve.



DRAWING 35

### Submenu



DRAWING 36

# CONTROL PANEL AND REMOTE CONTROL

## ◆ Video Image

**Brightness:** Adjusts the brightness of the image.

**Contrast:** Adjusts the contrast of the image

**Color Satur. :** Adjusts color saturation of the image.

**Sharpness:** Adjusts the sharpness of the image.

**Tint:** Adjusts the color balance of red and green .

**Image Mode:** See "Image Mode" in the "Computer Image" section.



**DRAWING 37**

## 3-2-2-3 DISPLAY

**Aspect Ratio:** Selects your desired aspect ratio.

**Zoom:** Increases or reduces the size of the image.

**Keystone:** Adjusts image distortion caused by tilting the projection.

**Color Temperature:** Adjusts the color temperature of the image. A higher color temperature looks colder. A lower color temperature looks warmer. When the color temperature is set to User mode, press "Down" button to select Red, Green, or Blue adjustment.

**Red, Green, Blue:** Increases or decreases the value to find the desired color temperature.



**DRAWING 38**

# CONTROL PANEL AND REMOTE CONTROL

## 3-2-2-4 AUDIO

**Volume:** Adjusts the volume of the internal or wireless speaker.

**Treble:** Adjusts the treble audio of the internal or wireless speaker

**Bass:** Adjusts the Bass audio of the internal or wireless speaker.

**Mute:** Mutes the internal or wireless speaker.

**Int/Ext Speaker:** Selects the internal or wireless speaker. If you select wireless speaker, press the "Down" button to get the wireless channel selection. Set the wireless speaker channel to match the wireless speaker channel set on the projector. Press the "Enter" button to return to the main menu.

**Wireless CH.:** Sets the wireless channel.



**DRAWING 39**

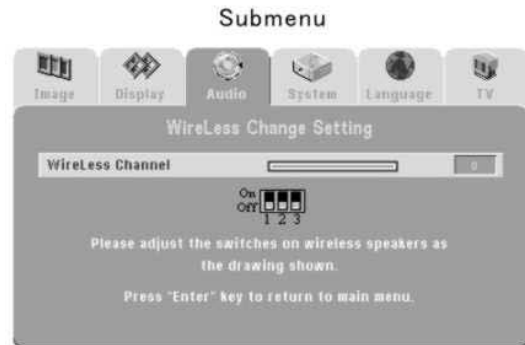

**DRAWING 40**

## 3-2-2-5 SYSTEM

**OSD Location:** Chooses the OSD location on the display screen.

**Projection:** Selects the projector's orientation.

**Front:** The factory default setting. For "tabletop" projection.

**Front Ceiling:** Inverts the image. For "ceiling mounted" projection.

**Rear:** Reverses the image. For "tabletop" rear projection

**Rear Ceiling:** Reverses and inverts the image. For "ceiling mounted" rear projection.

**Lamp Hours:** Displays the cumulative lamp operation time.

**Lamp Reset:** Resets the lamp operation time after changing lamps..

**Auto Source:** Detects the input source automatically.

**Factory Reset:** Resets all items in all menus to their default settings.



**DRAWING 41**

# CONTROL PANEL AND REMOTE CONTROL

## 3-2-2-6 LANGUAGE

Selects the Language you need.



DRAWING 42

## 3-2-2-7 TV

**Auto Search:** Searches channels automatically.

**Add Channel:** Adds the channel you need.

**Del Channel:** Deletes the channel you don't need.

**Fine Tune:** Mutes the internal speaker of projector or wireless speaker.

**Sound Mode:**

**Mono:** Outputs the mono sound.

**Stereo:** Outputs the stereo sound.

**Sub-Language:** Changes the main language to the sub-language.

**TV System:** Selects the NTSC or PAL system.

**NTSC:** Selects Country.

**PAL:** Selects region and volume system



DRAWING 43

### Submenu



DRAWING 44

### Submenu



DRAWING 45



# CONTROL PANEL AND REMOTE CONTROL

## 3-2-3 MEDIA PLAYER'S OSD

Press the "Setup" (red) button on the Remote Control to enter the Media Player's OSD.

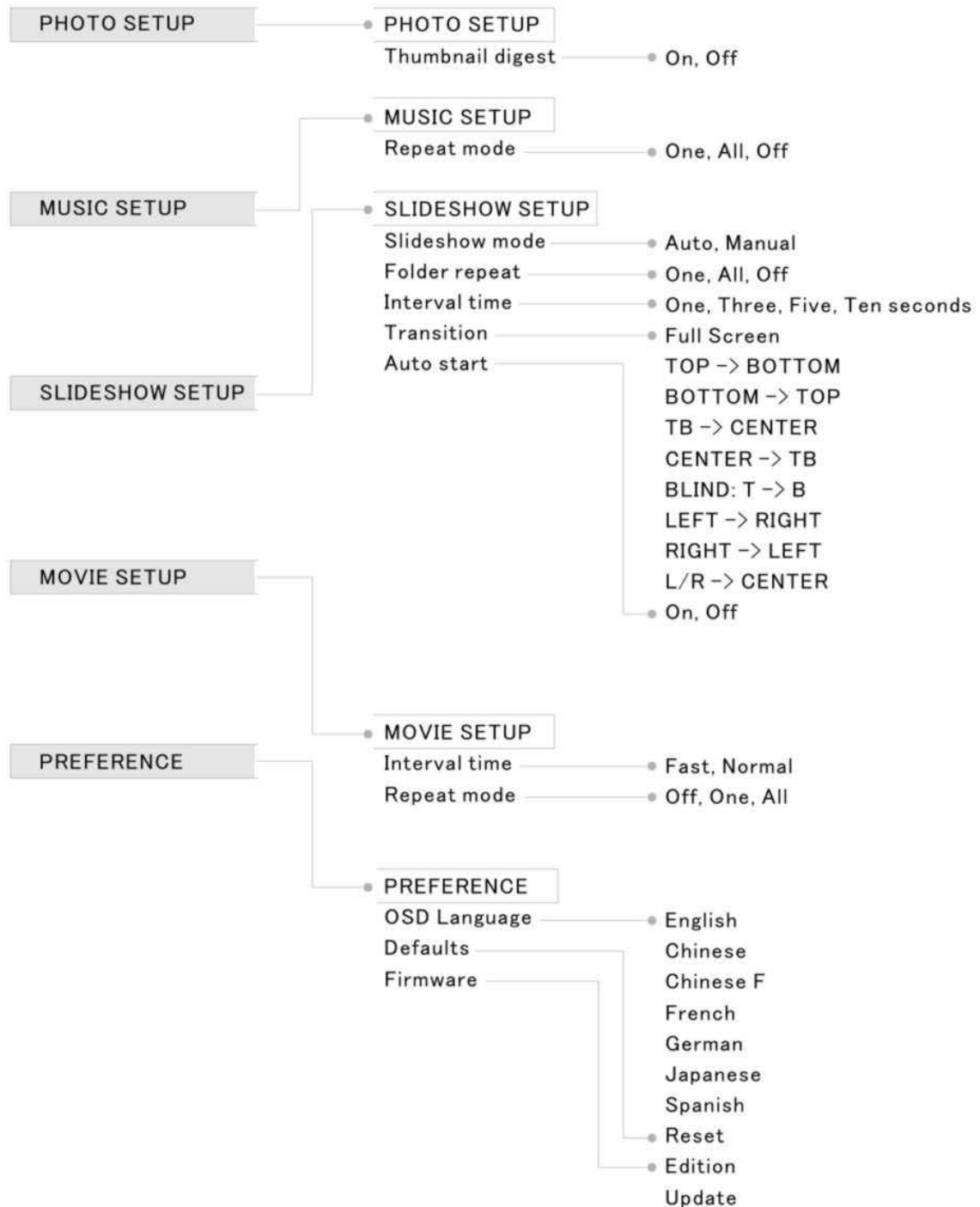

# CONTROL PANEL AND REMOTE CONTROL

## 3-2-3-1 MAIN MENU

The Menu can only be accessed from the Remote Control.

1. Press "Setup" button to show the main menu on screen
2. Press "Up" / "Down" button to select the item.
3. Press "Enter" button to enter the sub-menu.
4. Press "Right" button to set the function.
5. Press "Enter" button to confirm the setting
6. Press "Left" button to return the function item.
7. Select "EXIT SETUP" to exit the setup main.

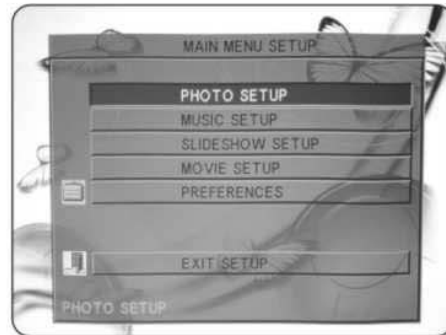

**DRAWING 46**

Main Menu includes:

PHOTO SETUP

MUSIC SETUP

SLIDESHOW SETUP

MOVIE SETUP

PREFERENCES

## 3-2-3-2 PHOTO SETUP

Digital cameras automatically store a thumbnail of each picture taken. These thumbnails load faster and allow you to browse photos more easily.

The Media Player can detect and display these thumbnails. The PHOTO SETUP function lets you turn the THUMBNAIL DIGEST on or off. If you select on, you can view your photos more quickly.



**DRAWING 47**

Submenu

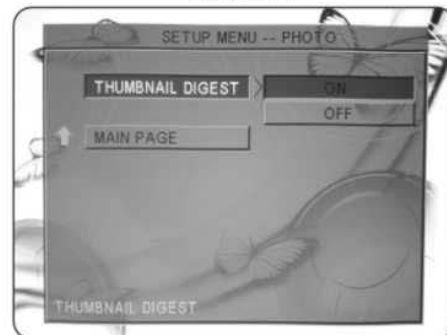

**DRAWING 48**

## CONTROL PANEL AND REMOTE CONTROL

### 3-2-3-3 MUSIC SETUP



**DRAWING 49**

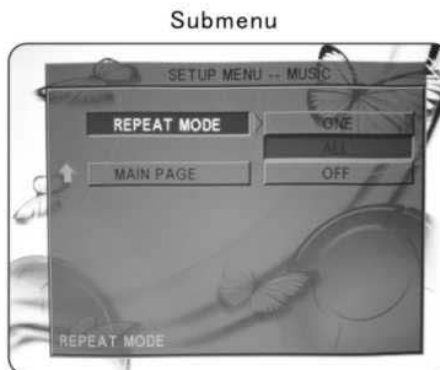

**DRAWING 50**

#### ◆ Repeat Mode

ONE: Repeats the selected song.

ALL: Repeats all the songs in the memory card.

OFF: Does not repeat any songs.

### 3-2-3-4 SLIDESHOW SETUP

- ◆ **DISPLAY MODE**: Set to cause the slideshow to start automatically.
- ◆ **REPEAT MODE**: Set to cause all photos in a folder to display consecutively and continuously (in a loop).
- ◆ **INTERVAL TIME**: Set the show time of each photo. (One, Three, Five, or Ten sec).
- ◆ **TRANSITION**: Set the transition mode between slides.

FULL SCREEN: Image appears full screen

TOP -> BOTTOM: Image rolls in from top to bottom

BOTTOM -> TOP: Image rolls in from bottom to top

TB -> CENTER: Image rolls in from top and bottom to center

CENTER -> TB: Image rolls from center to top and bottom

BLIND: T -> B: Image rolls in blinds from top to bottom

LEFT -> RIGHT: Image rolls in from left to right

RIGHT -> LEFT: Image rolls in from right to left

L/R -> CENTER: Image rolls in from left and right to center



**DRAWING 51**

#### Submenu

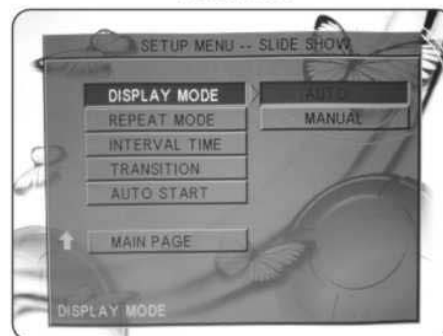

**DRAWING 52**

# CONTROL PANEL AND REMOTE CONTROL

- ◆ **AUTO START:** When turned on, any media in the memory card plays automatically when the card is inserted.

## 3-2-3-5 MOVIE SETUP

- ◆ **INTERVAL TIME**
  - FAST:** A short preview of movie plays in Thumbnail view.
  - NORMAL:** The whole movie plays in Thumbnail view.
- ◆ **REPEAT MODE**
  - OFF:** REPEAT MODE is turned off.
  - ONE:** Plays the selected movie continuously (loop).
  - ALL:** Plays all movies on the memory card continuously(loop).

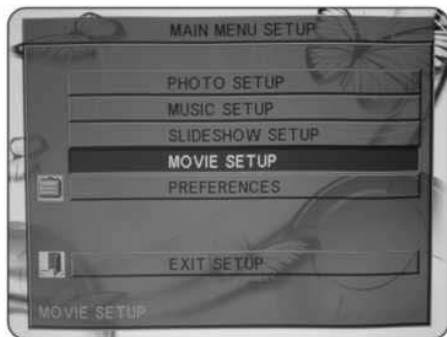

DRAWING 53

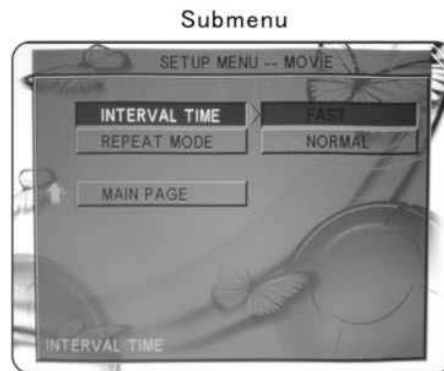

DRAWING 54

## 3-2-3-6 PREFERENCE

- ◆ **OSD LANG:** Selects the OSD language.
- ◆ **DEFAULTS:** Returns to the default value.
- ◆ **FIRMWARE:** Updates the firmware. (For service person use only)



DRAWING 55

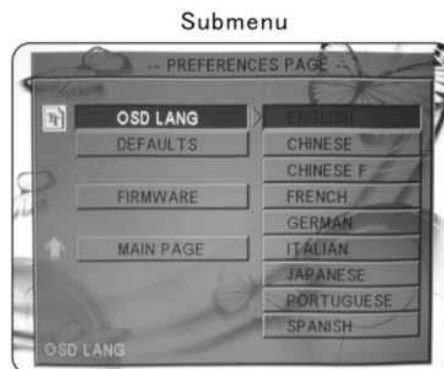

DRAWING 56

# CONTROL PANEL AND REMOTE CONTROL

## 3-2-4 DVD PLAYER'S OSD

Press the "Setup" (green) button on the Remote Control to enter the DVD player's OSD.

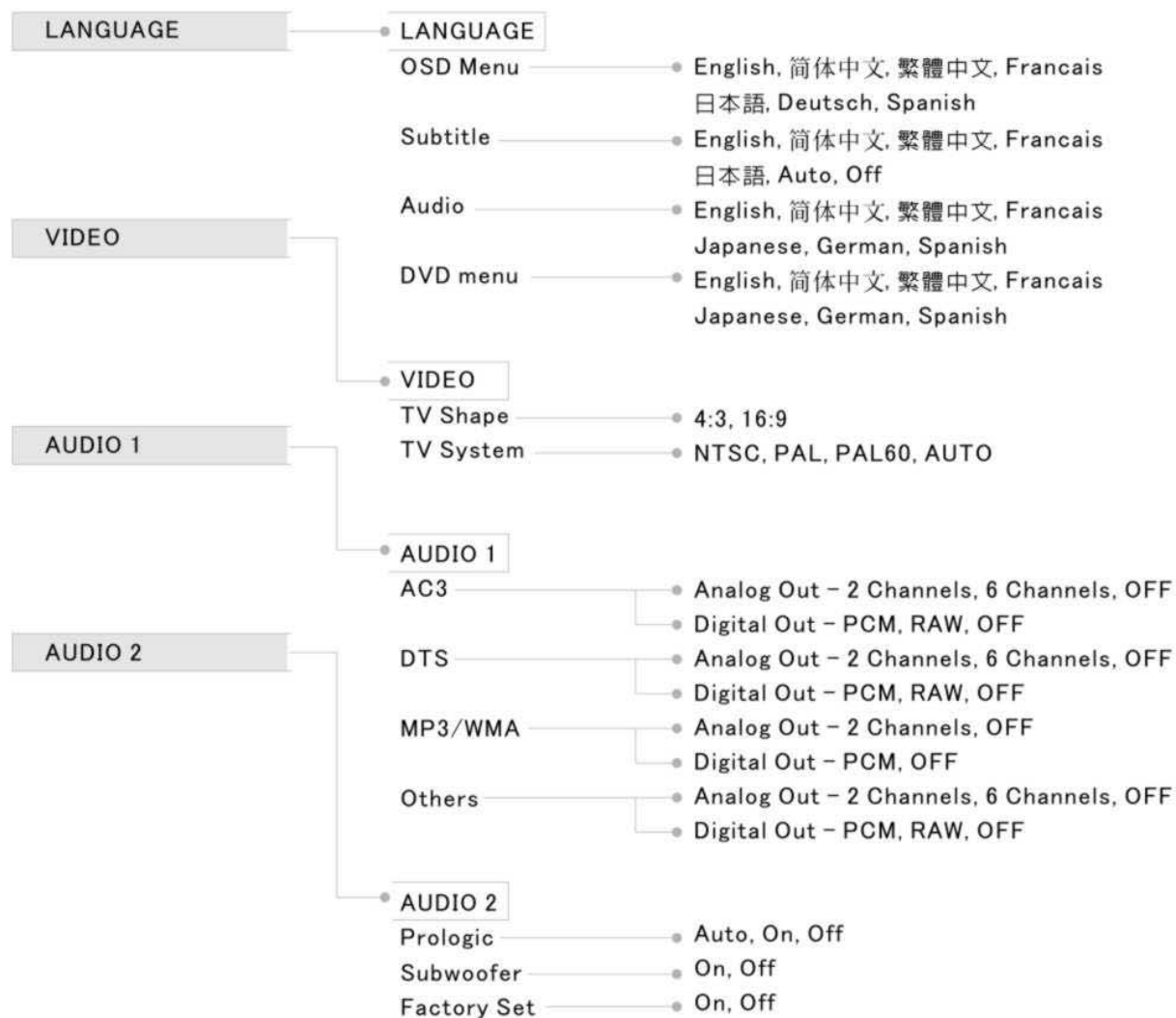

# CONTROL PANEL AND REMOTE CONTROL

## 3-2-4-1 MAIN MENU

The Menu can only be accessed from the Remote Control.

1. Press "Setup" button to show the main menu on screen.
2. Press "Right" or "Left" button to select the item you want.
3. Press "Enter" button to enter the sub-menu.
4. Press "Up" button to return the main menu.
5. Press "Setup" button to exit the menu.



DRAWING 57

## 3-2-4-2 LANGUAGE

### OSD Menu

Selects the Language of OSD Menu.  
(English, 簡體中文, 繁體中文, Francais, 日本語, Deutsch, Spanish)

### Subtitle

Selects the Language of subtitle.  
(English, 簡體中文, 繁體中文, Francais, 日本語, Auto, Off)

### Audio

Selects the Language of dub.  
(English, 簡體中文, 繁體中文, Francais, 日本語, Deutsch, Spanish)

### DVD Menu

Selects the Language of DVD Menu.  
(English, 簡體中文, 繁體中文, Francais, 日本語, Deutsch, Spanish)



DRAWING 58

## CONTROL PANEL AND REMOTE CONTROL

### 3-2-4-3 VIDEO

#### TV Shape

There are two aspect ratios to choose from:

4:3: The image will be displayed in 4:3 aspect.

16:9: The image will be displayed in 16:9 wide screen.

#### TV System

Selects system you need.



**DRAWING 59**

### 3-2-4-4 AUDIO 1

#### AC3, DTS, MP3/WMA, Others:

Analog Out: Selects the channels you need (2 or 6 channels)

Digital Out: PCM, RAW, OFF

RAW: Digital output

PCM: Analog output

Please set 2 channels and PCM when playing wireless stereo speaker.



**DRAWING 60**

## CONTROL PANEL AND REMOTE CONTROL

### 3-2-4-5 AUDIO 2

Prologic:

Auto: Default setting. The DVD player will automatically change the output from 2 channels to 6 channels.

On: Sets the function always on.

Off: Sets the function off.

Subwoofer:

On: Sets the subwoofer on.

Off: Sets the subwoofer off.

Factory Set:

On: Restores the default setting.

Off: Keeps the user's setting.



**DRAWING 61**



# APPENDICES

## 4-1 TROUBLESHOOTING

1. No Images appears
  - ◆ Check the power cable connection at the power inlet of the projector and at the wall outlet.
  - ◆ Confirm that the main power switch at the rear of the projector is in the on position.
  - ◆ Check the Standby/on button indicator. (Section 3-1)
  - ◆ Confirm that the lens cap has been removed.
  - ◆ Make sure the source device is properly connected to the projector, and is outputting a signal.
  - ◆ Press "Source" button on either the projector or the Remote Control to ensure that correct source is selected.
2. Image is blurred
  - ◆ Ensure the distance between the projector and the screen is within the focus range of the lens. (Section 2-2)
  - ◆ Adjust the focus ring.
3. Image is too dark
  - ◆ Adjust the contrast or brightness in the image menu of projector properly.
  - ◆ Adjust the brightness in the setup menu of DVD player.
  - ◆ Has the lamp reached the end of its life? If so replace the lamp.
4. Computer Image is unstable or the projector isn't projecting the whole image.
  - ◆ Press "SYNC" button either on the projector or the Remote Control to synchronize the computer output signal.
  - ◆ Use "Image" menu to adjust the tracking or frequency.
  - ◆ Verify that the computer's output resolution to the projector is less than or equal to 1024 x 768.
5. Image is stretched when displaying 16:9 DVD.
  - ◆ Adjust the "Aspect Ratio" in the OSD of projector.
  - ◆ Adjust the "TV Shape" in the OSD of DVD player.

6. No sound
  - ◆ Make sure the Mute option in Audio menu is off.
  - ◆ Make sure the Audio menu in DVD player's OSD is set properly.
  - ◆ Make sure the Internal/External speaker option in audio menu is set as required.
  - ◆ Make sure the channel of wireless transmitter selected in projector is the same as the channel of wireless receiver selected in the wireless speaker.
7. Wireless speaker noisy
  - ◆ Change the channels on the projector and wireless speaker simultaneously. There are 8 channels selectable.(refer to the Section 3-2-2-4)
8. Remote control does not work
  - ◆ Install new batteries.
  - ◆ Make sure there are no obstacles between you and the projector's receivers.
  - ◆ Make sure you are attempting to operate it within its usable range.
9. Can't read the memory card
  - ◆ Make sure the Media Player's LED indicator (beside the card slot) is lighting..
  - ◆ Check the compatibility of memory card (refer to section 2-3-2)
  - ◆ Re-insert the memory card.
10. Can't play DVD
  - ◆ Make sure the DVD player's LED indicator (on the control panel of the projector) is lighting
  - ◆ Confirm that the disc is an original edition.
  - ◆ Eject the disc and play again.
11. The disc can't play or is automatically ejected after loading
  - ◆ Make sure the disc is free from dirt and dust and is not damaged.
  - ◆ Make sure the disc is loaded with the label side face-up and aligned properly in the disc tray guide.
  - ◆ Make sure the disc format is compatible with the DVD player of the projector. Please refer to the specification.
12. The color of Image is not correct
  - ◆ Please reset all settings.

# APPENDICES

## 4-2 MAINTENANCE

### 4-2-1 REPLACING THE LAMP

When the lamp's total working time accumulates to over 1850 hours, the on-screen display (OSD) will deliver a message recommending that you replace the lamp. Please contact a service center to replace the lamp as soon as possible, or refer to the following instructions to replace it yourself.

#### TO REPLACE THE LAMP

1. Turn off the projector by pressing the "Power" button
2. Allow the projector to cool down for at least one hour.
3. Switch off the power and disconnect the power cord.
4. Loosen the screw on the lamp cover and remove the lamp cover. (Drawing 62)
5. Loosen two screws on the lamp module (Drawing 63) remove the lamp module by pulling on the handle (Drawing 64)
6. Insert a new lamp module (Drawing 65) into the socket: make sure it is in position.
7. Reverse steps 4 and 5
8. Ensure that the lamp cover is securely attached and flush with the bottom of the unit. The unit will not operate with the cover incorrectly installed.
9. Reset the lamp timer

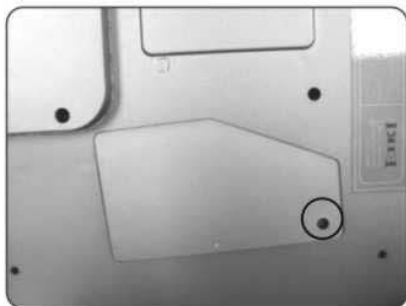

DRAWING 62

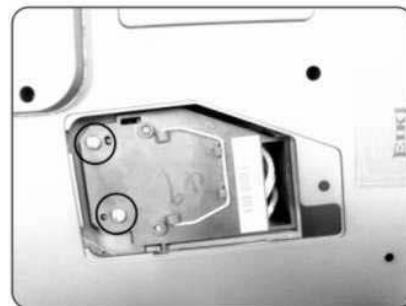

DRAWING 63

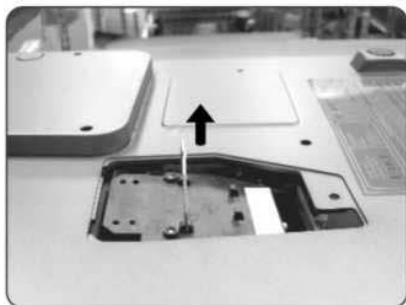

DRAWING 64

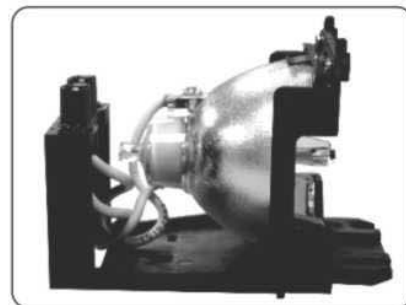

DRAWING 65

To reset the lamp timer

1. Press the Menu button on control panel or remote controller.
2. Go into the system menu and move the cursor to the lamp reset item.
3. Select "Yes" to execute the lamp reset and the lamp hours will reset to 0 hour.



DRAWING 66

IMPORTANT

- \*Do not touch the lamp immediately after it has been used: it will be extremely hot. Allow the fan to finish its cooling process, then turn the projector off, and disconnect the power cord. Then allow at least one hour for the lamp to cool down before handling.
- \*Do not remove any screws other than the lamp cover screw and the lamp housing screws. Removing other screws could result in electric shock.
- \*Although the mercury content of the lamp is minuscule, spent lamps should be treated as hazardous waste. Consult federal, state/provincial or local regulations for proper disposal.

CAUTION

Continuing to use the lamp after the replace the lamp message has been displayed on the screen may result in the lamp exploding. If this occurs, pieces of glass may scatter inside the projector, and out into the room. If this occurs, do not touch them, as the pieces of glass may cause injury. The bulb contains a small amount of mercury: ventilate the area well. Contact your dealer for servicing: do not attempt to service the projector yourself.

## APPENDICES

### 4-2-2 CLEANING THE PROJECTOR

#### Cleaning the cabinet

Wipe lightly with a soft, dry cloth. If the cabinet is very dirty, clean it with a soft, dampened cloth using mild commercial cleaner and finish with a dry cloth. Do not use liquid or aerosol cleaners.

#### Cleaning the lens

Clean the lens carefully by using a blower or lens paper to prevent creating any scratches on lens.



## 4-3 SPECIFICATION

Color system	NTSC/PAL/SECAM/NTSC4.43
Computer compatibility	SXGA (Compression) /XGA/SVGA/VGA/Mac
Screen size (diagonal)	Adjustable from 35" to 300"
Throw distance	1.5m - 10m
Brightness	1800 ANSI lumens
Contrast ratio	2000 : 1
DMD panel	Single 0.7" DDR XGA DMD
Color wheel	4 segmentations
Number of pixels	786,432 (1024 x 768)
Horizontal resolution	480 TV Lines (S-Video)
Projection lens	F2.8~ 3.1, f = 25.8 ~ 30 mm, Zoom ratio: 1.2:1
Lens shift (U/D ratio)	10 : 0
Projection lamp	250 W, Lamp life: 2000 hours (Normal mode) / 3500 hours (Eco mode)
Digital Zoom	Max. X32 for XGA mode
Digital Keystone	+/- 12 degrees (Vertical)
Picture Reverse Scan	Left/Right and Top/Bottom
Front Elevation / Maximum tilt angle	Up to 15 degrees / 45 degrees up and down
Scanning frequency	Automatic frequency control H sync. 15kHz~82kHz, V sync. 50Hz~85Hz
Operating temperature	5°C to +35°C
Fan noise	32dBA
Computer Input	Dsub 15 x1
Computer Output	Dsub 15 x1
Video	Component (HDTV, EDTV) input: RCA Jack x3, RCA x1 (Composite), Mini DIN 4-pin x1, RCA x2 (R, L-mono)
Audio Out	3.5mm mini Jack x 1: Audio Out 3.5mm mini Jack x 3: Audio 5.1 channel output
Built-in Speaker	2W x 1
Wireless Speaker	Stereo 25W x 2 Dimension (WxDxH): 170x180x270 mm(6.7" x 7.1" x 10.6") Weight: 8.35 Kg
Power Supply	100 - 240V, 50 - 60Hz
Power consumption	330W
Dimensions (WxDxH)	374 x 290 x 92mm (14.7" x 11.4" x 3.6")
Net weight	4.5 kg (10 lb)
Regulations	1. EMC - FCC Class B, CE Class B, CCC 2. Safety - cUL, TUV, CB
Standard Accessories	Power cord VGA Cable Audio Cable Mac Adapter Remote Control Soft Carry Bag for projector 25W x 2 Wireless speakers
Optional Accessories	TV tuner Deluxe speaker Satellite speaker Soft Carry Case for Wireless Speakers

# EIKI

A-key to better communications

## U.S.A.

EIKI International, Inc.  
30251 Esperanza  
Rancho Santa Margarita  
CA 92688-2132  
U.S.A.  
Tel : 800-242-3454 (949)-457-0200  
Fax : 800-457-3454 (949)-457-7878  
E-Mail : usa@eiki.com

## Deutschland & Österreich

EIKI Deutschland GmbH  
Am Frauwald 12  
65510 Idstein  
Deutschland  
Tel : 06126-9371-0  
Fax : 06126-9371-14  
E-Mail : info@eiki.de

## Canada

EIKI CANADA - Eiki International, Inc.  
P.O. Box 156, 310 First St. - Unit 2,  
Midland, ON, L4R 4K8, Canada  
Tel : 800-563-3454 (705)-527-4084  
Fax : 800-567-4069 (705)-527-4087  
E-Mail : canada@eiki.com

## Eastern Europe

EIKI CZECH spol. s.r.o.  
Umělecká 15  
170 00 Praha 7  
Czech Republic  
Tel : +42 02 20570024  
+42 02 20571413  
Fax : +42 02 20571411  
E-Mail : easterneurope@eiki.de

## Japan & World wide

EIKI Industrial Company Limited.  
4-12 Banzai-Cho, Kita-Ku, Osaka,  
530-0028 Japan  
Tel : +81-6-6311-9479  
Fax : +81-6-6311-8486  
E-Mail : japan@eiki.com

WorldWide Website <http://www.eiki.com>